









- 1 
- 2 
- 3 
- 4 
- 5 
- 6 
- 7 
- 8 
- 9 
- 10 
- 11 
- 12 
- 13 
- 14 
- 15 
- 16 
- 17 
- 18 
- 19 

**VERSIONS**

- Type **C1** chamfer, top
- Type **C2** chamfer, bottom
- Type **C3** chamfer, right
- Type **C4** chamfer, left

**GUIDE**

- Steel precision casting
- Zinc plated, blue passivated **ZB**
- Zinc plated and powder coated
- Black, RAL 9005, textured finish **SW**
- Stainless steel precision casting AISI CF-8 **NI**

**LIFTING RING**

- Steel precision casting
- Zinc plated, blue passivated (for **ZB** and **SW**)
- Stainless steel precision casting AISI CF-8 (for **NI**)

**PLUNGER**

- Steel, case-hardened
- Zinc plated, blue passivated **ZB** and **SW**
- Stainless steel AISI 431, hardened **NI**

**SPRING**

AISI 316Ti stainless Steel

**FEATURES AND APPLICATIONS**

Indexing plungers GN 724.5 have a plunger pin with square cross-section, a latching surface on one side and a chamfer on the other. When the object to be secured moves towards the chamfer, the plunger pin is pushed back into the guide, allowing grooves and edges to pass over the pin. The plunger pin engages automatically in the direction of the latching surface.

The latching can be released by pulling the pull ring by hand or with a cable or pull rod using a hook. The types with rest position are used when the plunger pin should temporarily not protrude. For this purpose, the pull ring is turned sideways after the plunger pin has been retracted. The ring is held in this position by the catch recess at the top of the guide.

The dimensional tolerances between the pin and the guide have been chosen to ensure functional reliability even in roughly dimensioned applications or in the event of soiling.

There are several options for fastening. The hex mounting holes allow the use of socket cap screws DIN 912 and hex head screws or nuts according to DIN 931 or DIN 934.



GN 724.5-C1

GN 724.5-C2

GN 724.5-C3

GN 724.5-C4

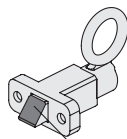

Chamfer

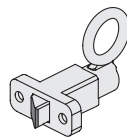
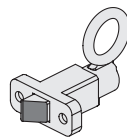
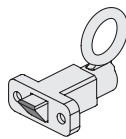

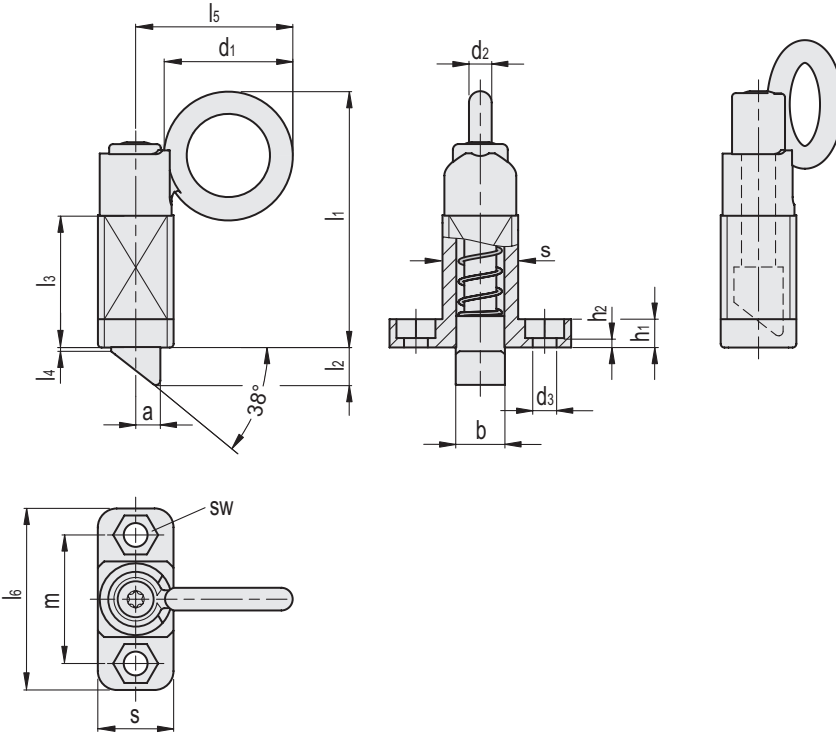

**GN 724.5-C1**

Code	Description	d1	d2	d3 +0.2	a	b	h1	h2	l1	l2	l3	l4	l5	l6	s	sw	m	Spring preload [N]	Spring max load [N]	△
GN.78732	GN 724.5-13-20-C1-SW	34	6	6.1	6.5	13	7.5	1.5	68	10	35	1	41.5	48	20	10	34	14	35	172
GN.78733	GN 724.5-13-20-C1-ZB	34	6	6.1	6.5	13	7.5	1.5	68	10	35	1	41.5	48	20	10	34	14	35	172
GN.78752	GN 724.5-20-30-C1-SW	48	9	10.1	10	20	15	5	102	15	54	1.5	60	80	30	17	55	22	70	639
GN.78753	GN 724.5-20-30-C1-ZB	48	9	10.1	10	20	15	5	102	15	54	1.5	60	80	30	17	55	22	70	639

**GN 724.5-C2**

Code	Description	d1	d2	d3 +0.2	a	b	h1	h2	l1	l2	l3	l4	l5	l6	s	sw	m	Spring preload [N]	Spring max load [N]	△
GN.78735	GN 724.5-13-20-C2-SW	34	6	6.1	6.5	13	7.5	1.5	68	10	35	1	41.5	48	20	10	34	14	35	172
GN.78736	GN 724.5-13-20-C2-ZB	34	6	6.1	6.5	13	7.5	1.5	68	10	35	1	41.5	48	20	10	34	14	35	172
GN.78755	GN 724.5-20-30-C2-SW	48	9	10.1	10	20	15	5	102	15	54	1.5	60	80	30	17	55	22	70	639
GN.78756	GN 724.5-20-30-C2-ZB	48	9	10.1	10	20	15	5	102	15	54	1.5	60	80	30	17	55	22	70	639

**GN 724.5-C3**

Code	Description	d1	d2	d3 +0.2	a	b	h1	h2	l1	l2	l3	l4	l5	l6	s	sw	m	Spring preload [N]	Spring max load [N]	△
GN.78738	GN 724.5-13-20-C3-SW	34	6	6.1	6.5	13	7.5	1.5	68	10	35	1	41.5	48	20	10	34	14	35	172
GN.78739	GN 724.5-13-20-C3-ZB	34	6	6.1	6.5	13	7.5	1.5	68	10	35	1	41.5	48	20	10	34	14	35	172
GN.78758	GN 724.5-20-30-C3-SW	48	9	10.1	10	20	15	5	102	15	54	1.5	60	80	30	17	55	22	70	639
GN.78759	GN 724.5-20-30-C3-ZB	48	9	10.1	10	20	15	5	102	15	54	1.5	60	80	30	17	55	22	70	639

**GN 724.5-C4**

Code	Description	d1	d2	d3 +0.2	a	b	h1	h2	l1	l2	l3	l4	l5	l6	s	sw	m	Spring preload [N]	Spring max load [N]	△
GN.78741	GN 724.5-13-20-C4-SW	34	6	6.1	6.5	13	7.5	1.5	68	10	35	1	41.5	48	20	10	34	14	35	172
GN.78742	GN 724.5-13-20-C4-ZB	34	6	6.1	6.5	13	7.5	1.5	68	10	35	1	41.5	48	20	10	34	14	35	172
GN.78761	GN 724.5-20-30-C4-SW	48	9	10.1	10	20	15	5	102	15	54	1.5	60	80	30	17	55	22	70	639
GN.78762	GN 724.5-20-30-C4-ZB	48	9	10.1	10	20	15	5	102	15	54	1.5	60	80	30	17	55	22	70	639



- 1
- 2
- 3
- 4
- 5
- 6
- 7
- 8
- 9
- 10
- 11
- 12
- 13
- 14
- 15
- 16
- 17
- 18
- 19

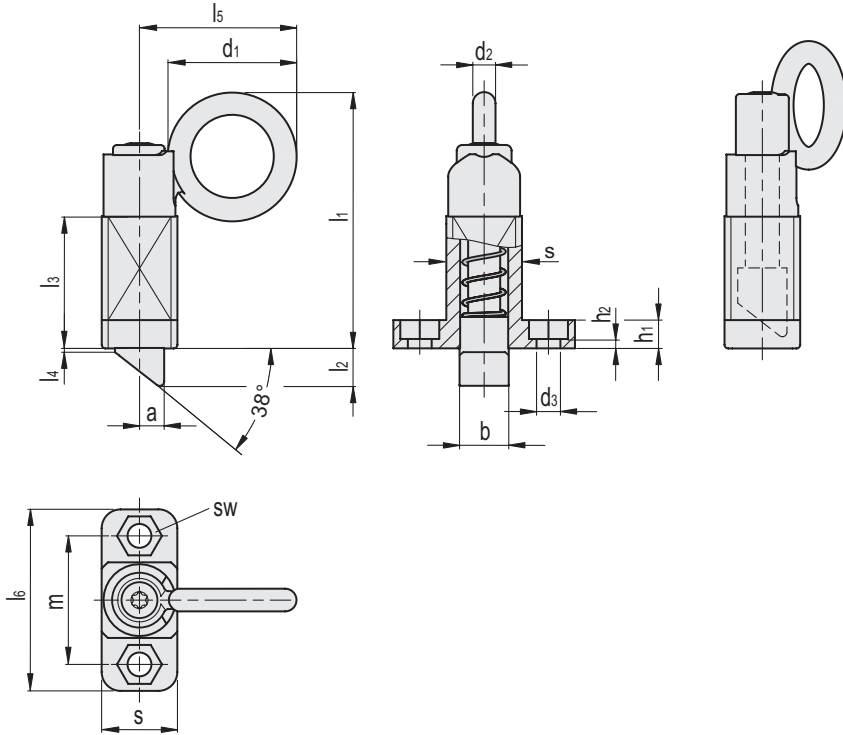

**INOX** STAINLESS STEEL

**GN 724.5-C1-NI**

Code	Description	d1	d2	d3 +0.2	a	b	h1	h2	l1	l2	l3	l4	l5	l6	s	sw	m	Spring preload [N]	Spring max load [N]	⚖
GN.78731	GN 724.5-13-20-C1-NI	34	6	6.1	6.5	13	7.5	1.5	68	10	35	1	41.5	48	20	10	34	14	35	173
GN.78751	GN 724.5-20-30-C1-NI	48	9	10.1	10	20	15	5	102	15	54	1.5	60	80	30	17	55	22	70	643

**GN 724.5-C2-NI**

Code	Description	d1	d2	d3 +0.2	a	b	h1	h2	l1	l2	l3	l4	l5	l6	s	sw	m	Spring preload [N]	Spring max load [N]	⚖
GN.78734	GN 724.5-13-20-C2-NI	34	6	6.1	6.5	13	7.5	1.5	68	10	35	1	41.5	48	20	10	34	14	35	173
GN.78754	GN 724.5-20-30-C2-NI	48	9	10.1	10	20	15	5	102	15	54	1.5	60	80	30	17	55	22	70	643

**GN 724.5-C3-NI**

Code	Description	d1	d2	d3 +0.2	a	b	h1	h2	l1	l2	l3	l4	l5	l6	s	sw	m	Spring preload [N]	Spring max load [N]	⚖
GN.78737	GN 724.5-13-20-C3-NI	34	6	6.1	6.5	13	7.5	1.5	68	10	35	1	41.5	48	20	10	34	14	35	173
GN.78757	GN 724.5-20-30-C3-NI	48	9	10.1	10	20	15	5	102	15	54	1.5	60	80	30	17	55	22	70	643

**GN 724.5-C4-NI**

Code	Description	d1	d2	d3 +0.2	a	b	h1	h2	l1	l2	l3	l4	l5	l6	s	sw	m	Spring preload [N]	Spring max load [N]	⚖
GN.78740	GN 724.5-13-20-C4-NI	34	6	6.1	6.5	13	7.5	1.5	68	10	35	1	41.5	48	20	10	34	14	35	173
GN.78760	GN 724.5-20-30-C4-NI	48	9	10.1	10	20	15	5	102	15	54	1.5	60	80	30	17	55	22	70	643

Indexing and positioning elements